



"The K-9 BSD is the greatest device invented for training a scent detection dog."

K-9 BSD-4 Remote Reward Launcher USER GUIDE

**US Patent - US 7,334,541 B2 - Animal Behavior Shaping Device
US Patent - US 8,104,458 ----- K9 Remote Reward Launcher**

K-9 BSD, LLC is the owner of all US Patent rights and the registered trademark K-9 BSD & Behavior Shaping Device.

Important Notices

- Read the operating instructions before using the **K-9 BSD-4 remote reward launcher**.
- **Do not insert your fingers or other part of the body into the hole intended for the reward – THIS MAY CAUSE SERIOUS INJURY!**
- The reward launcher can be operated only by persons over 18 years of age.
- Do not place the transmitter near objects sensitive to magnetic fields as this may cause their permanent damage.
- Batteries in the receiver and transmitter must be replaced every two years, even if the kit has not been used for a long time. Never leave a discharged battery in the device – it could damage your device.
- Used batteries must be disposed in a place designated for this purpose.
- Persons with devices supporting cardiac activity (pacemakers, defibrillators) must take appropriate precautions. K-9 BSD-4 remote reward launcher radiates a certain static magnetic field.

Contents

Introduction	3
Package Contents.....	3
Optional Accessories.....	3
Product Description	4
Transmitter.....	4
Reward Launcher.....	5
Transmitter Preparation	6
Insertion (Replacement) of the Battery in the Transmitter.....	6
Checking the State of the Battery in the Transmitter.....	6
Preparing the Launcher.....	6
Insertion (Replacement) of the Batteries in the Launcher	6
Checking the State of the Batteries in the Launcher	7
Switching ON/OFF.....	7
Pairing the Transmitter with the Launcher.....	8
K-9 BSD-4 Control.....	8
Features of the Transmitter.....	9
Maximum Range of the Transmitter.....	9
Troubleshooting	9
Maintenance.....	10
Technical Data.....	10
Warranty Terms and Conditions.....	11
Contact Information.....	11

Introduction

K-9 BSD-4 is a remote-controlled launcher of balls that serves for training of Police & Military service dogs, agility and regular dog training. Expectation of a "live" reward in the form of a shot ball motivates the dog to fulfill tasks faster, more precisely and with joy. After each exercise, the dog will receive the reward only if he deserves it.

The reward is ejected from the device by means of a remote transmitter at a distance of up to 650 ft / 200 m away and up to a height of 9 ft / 3 m. If the reward launcher is fastened upright with the included strap or supported by the metal support in an inclined position, the range can be up to 18 ft / 6 m. Low profile of the K-9 BSD-4 (4" tall / 105 mm) allows for easy camouflage. The transmitter can control up to 4 launchers and can be combined with ball droppers. The system is suitable for training centers and home use.

Package contents

- Transmitter
- Reward Launcher
- Lithium Battery CR2 3V
- Alkaline Batteries AA 1.5V- 4 pcs
- Strap for hanging the Reward Launcher
- Ball
- Pins for attaching the launcher to the ground - 2 pcs
- Metal Support – launching the ball in the distance
- Lanyard
- User Guide

Optional accessories

- Spare Transmitter and additional reward launchers
- Spare Battery
- Spare Rewards (different types)

Product Description

K-9 BSD-4 Remote Reward Launcher - Transmitter

1. Indicators
2. Acoustic signal buttons for launcher 1 to 4
3. Reward launch buttons for launcher 1 to 4
4. Neck strap hole for Lanyard
5. Battery compartment cover

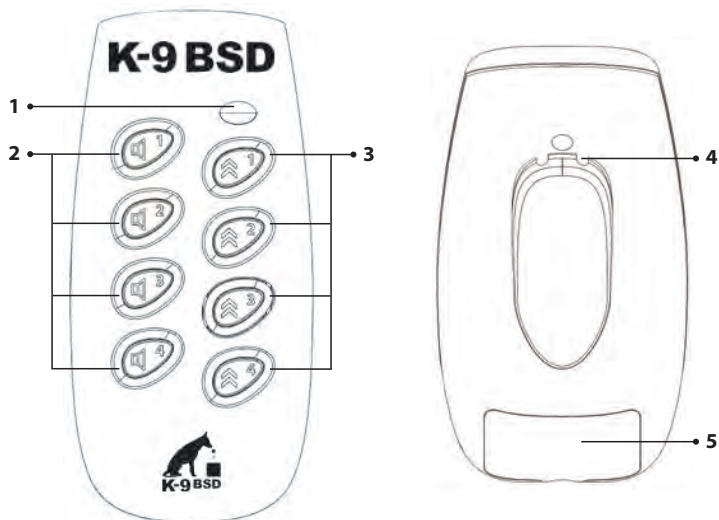

K-9 BSD-4 Remote Reward Launcher

1. Space for inserting the reward
2. Holes for pins attaching the reward launcher to the ground
3. Eyelet for lacing the strap to hang the reward launcher
4. Indicators
5. Target – a place for applying the magnet – switching on/off
6. Battery compartment cover
7. Holes for inserting the metal support
8. Metal support

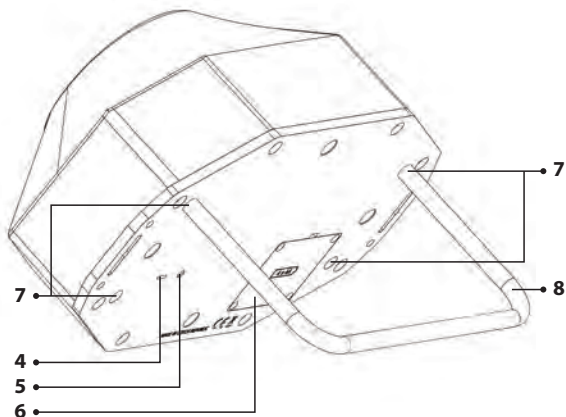
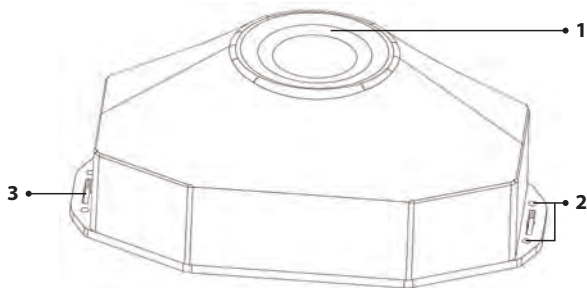

Transmitter Preparation

Replacement of the battery in the transmitter

1. Unscrew the screw on the back of the battery compartment cover using a cross-head screwdriver and open the cover carefully.
2. Insert the CR2 3V battery correctly regarding its polarity. The polarity is indicated in the battery compartment (see the photo).
3. Insert the battery compartment cover back into its position and tighten its screw with adequate force.
4. When the battery is inserted, the transmitter is always in the standby mode.

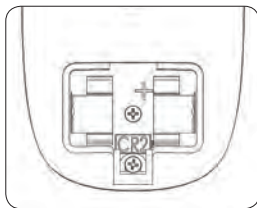

Checking the state of the battery in the transmitter

Discharged battery is indicated by the red indicator when any button is pressed. When the battery becomes low, the transmitter performance (radio range) is reduced. If the battery is discharged, insert a new CR2 3V lithium battery into the transmitter. After changing the battery, it is necessary to press twice any button on the transmitter for correct battery indication.

TIP: The battery can be removed easily when using a small screwdriver inserted carefully under the battery edge.

Preparing the Reward Launcher

Replacement of the batteries in the reward launcher

1. Unscrew the four screws of the battery compartment cover on the bottom side of the launcher (indicated by the battery symbol) using a cross-head screwdriver.
2. Push the battery holder out.
3. Insert four AA alkaline batteries correctly regarding their polarity (polarity is indicated on the battery holder).
4. Push the battery holder back – the battery holder must be correctly rotated (see the figure).
5. Check the rubber seal in the slot of the battery compartment cover for correct placement. Take care of the seal cleanness.
6. Insert the battery compartment cover back into its position and tighten all four screws with adequate force.

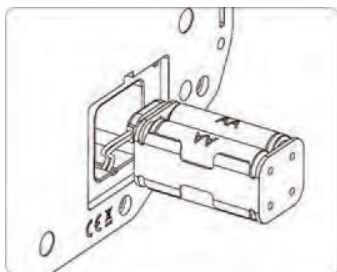

Checking the state of the batteries in the reward launcher

The state of the batteries is checked by flashing indicators on the bottom side of the launcher.

- **Charged battery** – the green indicator flashes when the reward launcher is switched on.
- **Low battery** – the green and red indicator flashes simultaneously when the reward launcher is switched on.

If the batteries are discharged, insert new alkaline AA batteries into the reward launcher.

Switching ON/OFF

To switch on/off the reward launcher, a magnetic switching system is used. The system is activated by attaching a magnet. The magnet is attached at the bottom part of the transmitter.

Switching on:

1. Attach the bottom part of the transmitter **between the red round target and the clear LED window** on the bottom side of the launcher – the red indicator and then the green indicator will turn on.
2. Take the transmitter away from the launcher when the green indicator is on. The green indicator will start flashing.

Switching off:

1. Attach again the bottom part of the transmitter **between the red round target and the clear LED window** on the bottom side of the launcher – the green indicator and then the red indicator will turn on.
2. Take the transmitter away from the reward launcher when the red indicator is on. The indicators will stop flashing.

Important: When switching on the reward launcher, you need to attach the transmitter **between the red target and the clear LED window** of the launcher for approximately 1 second. If you hold the transmitter at the target for more than 5 seconds, the receiver enters the mode of pairing the transmitter with the launcher. If this happens, follow the chapter *“Pairing the transmitter with the launcher”* on pg. 8.

CAUTION: To extend the battery life, the reward launcher must always be turned off after training. We recommend removing the battery completely if you do not use the reward launcher for a long time.

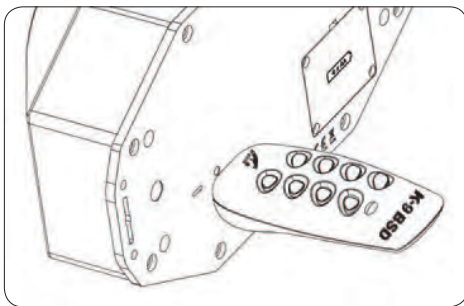

Pairing the transmitter with the reward launcher

Each transmitter has its radio operating codes. The transmitter communicates with your reward launcher only after mutual pairing. When buying a new set, the transmitter is paired with the reward launcher. Pairing is necessary if you want to pair other reward launchers or ball droppers with your transmitter. Reward launchers and droppers can be combined on one remote.

Important: Before pairing the transmitter and launcher, make sure that no one else uses his/her reward launcher or ball dropper in your vicinity. Your reward launcher could receive the code of another transmitter. Your reward launcher would then be controlled by someone else. If this happens, pair your reward launcher with your transmitter.

Pairing procedure

Switch off the reward launcher before starting pairing (no indicator flashes).

Do not load the reward launcher before pairing – risk of injury.

Attach the bottom side of the transmitter **between the red target and the clear LED window** on the bottom side of the reward launcher for 5 seconds. The red indicator and then the green indicator will turn on.

2. After 5 seconds, both indicators will flash three times at the same time.
3. Take the transmitter away from the reward launcher.
4. **Press the tone signal button**  **on the transmitter** (position 1 to 4 depending on which position you want to pair with the given reward launcher).
5. Successful pairing is indicated by a long beep of the reward launcher.

K-9 BSD-4 Control



Loading the reward launcher

1. Place the reward on the launching bowl
2. Push the reward by your palm to the bottom of the reward launcher
3. If you have a BSD-4 with barrel, insert a ball or large Kong upside down into the barrel and push down on the ball or Kong with the supplied cocking stick.

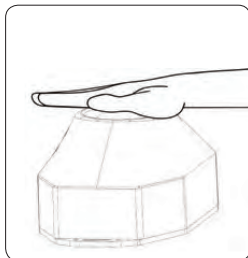
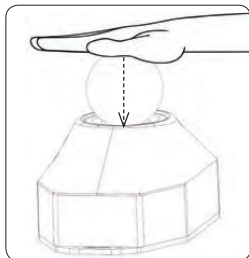
CAUTION: Load the reward launcher with rewards only. Do not insert your fingers or other part of the body into the loaded reward launcher – this may cause serious injury. The reward launcher can be operated only by persons over 18 years of age.



Features of the Transmitter

The K-9 BSD-4 transmitter allows you to control 4 reward launchers or ball droppers (buttons numbered 1 to 4). After pressing the  button, the launcher will emit a tone signal. This function serves to alert the dog to the place where his reward in the form of a launched reward is to be expected. The reward is launched from the reward launcher by pressing the  button. The reward ejection height is up to 9 ft (3 m) (depending on the weight of the reward used). It is possible to use any reward up to the diameter of 2.5" / 75 mm. The reward launcher can be hung upright or supported by the metal support to launch rewards away. The reward can be launched sideways to the distance up to 18 ft / 6 m.

Maximum Range of the Transmitter

The K-9 BSD-4 can be used up to 650 ft / 200 m. However, the maximum range is influenced by a number of factors – weather, terrain, vegetation, etc.

To ensure maximum range of your device:

- Do not cover the antenna at the top of the transmitter.
- When transmitting the command, hold the transmitter in the vertical position away from the body and in the extended arm over your head.
- Check the battery in the transmitter and receiver; replace it when necessary.

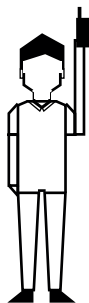

maximum range

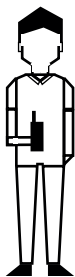

regular range

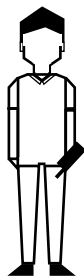

minimum range

Troubleshooting

1. Read these operating instructions again and check whether the problem is not caused by low batteries or improper use.
2. Make sure that the batteries are inserted with the correct polarity.
3. If the transmitter does not communicate with the reward launcher, try to pair devices again (see chapter – **Pairing the transmitter with the reward launcher** on pg. 8).
4. If the launching bowl gets jammed in the bottom position (dirt around the launching bowl), turn the launcher upside down and tap the ground slightly with it. This will result in removing any dirt around the launching bowl and the bowl will get unblocked.
5. Contact us if the problem persists.

Maintenance

Do not use volatile substances such as solvents, petrol or other cleaners to clean your K-9 BSD-4 . Use a soft damp cloth and, if necessary, also a neutral detergent.

The transmitter is only resistant to dripping water – protect it from moisture. Permanent damage may occur if moisture penetrates inside the unit. This damage is not covered by the warranty.

The launcher contains waterproof electronics and battery. Protect the launcher from heavy rain. If the water enters the launcher, the launching motor can be damaged and the springs may corrode. Ensure that the seal in the battery compartment cover is not damaged or dirty – it may cause moisture penetration. Check that the battery compartment cover screws are tightened.

Remove batteries from the transmitter and launcher if you do not use your K-9 BSD over a longer period.

Technical Data

Transmitter

Range	650 ft / 200 m (direct visibility)
Power Supply	lithium battery CR2 3V
Battery Life	6–12 months depending on usage
Frequency	869,525 Mhz
Antenna	integrated
Protectionnot waterproof
Operating Temperature	14°F to 122°F (–10°C to +50°C)
Weight	2.1oz (61 g)(without the battery)
Dimension.....	4.25" long x 2" wide x 1" height (110 × 52 × 29 mm)

K-9 BSD-4 Remote Reward Launcher

Launch Height	up to 9 ft (3 m) (depending on the reward weight)
Launch Distance.	up to 18 ft (6 m) (depending on the reward weight and launch angle)
Maximum Reward Diameter	2.5" (75 mm)
Power supply	4 alkaline batteries AA; 1,5V
Battery life	6 months depending on usage
Antenna	integrated
Protectionnot waterproof
Operating temperature	14°F to 122°F (–10°C to +50°C)
Weight	1.7lbs. (810 g)
Dimensions.....	12" long x 5.5" wide x 4" tall (255 × 105 × 140 mm)

Warranty Terms and Conditions

The warranty does not cover the following items:

- Batteries
 - Strap with eyes for hanging
 - Direct or indirect risks during product transport to the seller
 - Damage to the product due to user negligence or accident (e.g. breaking, impact, etc.) and intervention of unauthorized persons.
1. The warranty period begins with the buyer's receipt of the goods. The condition for lodging a complaint at the seller is the submission of the confirmed warranty certificate or a proof of purchase.
 2. The warranty provided does not apply to product defects that originated due to:
 - a) improper installation or failure to observe the instructions from the manufacturer's manual.
 - b) improper use of the product.
 - c) inappropriate storage or care of the product.
 - d) unauthorized interference or repairs performed without the manufacturer's knowledge.
 - e) natural disaster or other inescapable event.
 - f) change of the goods made by the consumer if such a change results in damage or effect of the goods.
 - g) mechanical damage by the consumer.
 - h) other actions of the consumer that would conflict with these warranty conditions or instructions for use.
 3. The warranty cannot be claimed unless the goods have been fully paid or if the goods are from clearance.
 4. The complainant is required to prove the product defect, to allow the manufacturer to verify the eligibility of the product defects claim and to assess the extent of the defects. At the same time, he/she is obliged to hand over the product in a condition allowing the assessment of defects. The complainant is not authorized to repair the product by himself/herself or through a third party. Otherwise, he/she will lose entitlements arising from the manufacturer's liability for product defects.
 5. Consumer's claims arising from the manufacturer's liability for product defects are governed by general legal regulations. In the case of proven manufacturing defects, the manufacturer is obliged to replace the faulty product for faultless.
 6. Goods submitted for reclamation must be properly cleaned. The complaints department is entitled to refuse the goods for the complaint procedure if the general hygiene principles are not observed.
 7. If the product is sent in for repair or warranty work, it must be packed in a sufficient manner and secured against damage.
 8. For shipping, choose the most convenient way and carrier with regard to delivery availability and speed. We are not liable for the loss of the goods that you ship.

Contact Information

Phone: **270-554-8500** Email: **info@K-9BSD.com**

Address: **7660 Old US Hwy 45, Boaz, KY 42027**